

Delta Electronics, Inc.
HeTianXia High-Tech Industrial Park.
Shi Jie Town, Dong Guan City.
Guangdong Province, China. P. R. C.

TEL : 86-769-86329008
FAX : 86-769-86631589

STATEMENT OF DEVIATION

NONE

DESCRIPTION :

Delta Electronics, Inc.
 HeTianXia High-Tech Industrial Park.
 Shi Jie Town, Dong Guan City.
 Guangdong Province, China. P. R. C.

TEL : 86-769-86329008
 FAX : 86-769-86631589

SPECIFICATION FOR APPROVAL

Customer: DPC

 Description: DC FAN

 Customer P/N: REV:

 Delta Model NO.: QFR0812UHEYDW Delta safety model NO.: QFR0812UHE

 Sample Rev: 01 Issue NO:

 Sample Issue Date: FEB-16-2017 Quantity:

1. SCOPE:

THIS SPECIFICATION DEFINES THE ELECTRICAL AND MECHANICAL CHARACTERISTICS OF THE DC BRUSHLESS AXIAL FLOW FAN.

2. CHARACTERS:

ITEM	DESCRIPTION
RATED VOLTAGE	12 VDC
OPERATION VOLTAGE	10.8 - 13.2 VDC
INPUT CURRENT	1.15 (1.38 MAX.) A SAFETY CURRENT ON LABEL: 1.7A
INPUT POWER	13.80 (16.56 MAX.) W
SPEED	9000 ± 10% RPM
MAX. AIR FLOW (AT ZERO STATIC PRESSURE)	2.979 (MIN. 2.681) M ³ /MIN 105.21 (MIN. 94.69) CFM
MAX.AIR PRESSURE (AT ZERO AIR FLOW)	33.91 (MIN. 27.47)mmH ₂ O 1.335 (MIN. 1.081)inchH ₂ O
ACOUSTICAL NOISE (AVG.)	60.0 (MAX 64.0) dB-A
INSULATION TYPE	UL: CLASS A

(continued)

PART NO:

DELTA MODEL: QFR0812UHEYDW

INSULATION STRENGTH	10 MEG OHM MIN. AT 500 VDC (BETWEEN FRAME AND (+) TERMINAL)
DIELECTRIC STRENGTH	5 mA MAX. AT 500 VAC 50/60 Hz ONE MINUTE, (BETWEEN FRAME AND (+) TERMINAL)
LIFE EXPECTANCE (L10) (AT LABEL VOLTAGE)	L10 : 7 YEARS (61320 HOURS) L2 : 6 YEARS (52560 HOURS) ABOVE LIFE EXPECTANCE IS BASED ON 45 °C AND 60% MAX. ROTOR SPEED.
ROTATION	CLOCKWISE VIEW FROM NAME PLATE SIDE
OVER CURRENT SHUT DOWN	THE CURRENT WILL SHUT DOWN, WHEN LOCKING ROTOR.

- NOTES: 1. ALL READINGS ARE MEASURED AFTER STABLY WARMING UP THROUGH 10 MINUTES
2. STANDARD AIR PROPERTY IS AIR AT (Td) 25°C TEMPERATURE, (RH) 65% RELATIVE HUMIDITY, AND (Pb) 760 mmHg BAROMETRIC PRESSURE.
3. THE VALUES WRITTEN IN PARENS , (), ARE LIMITED SPEC.
4. ACOUSTICAL NOISE MEASURING CONDITION:

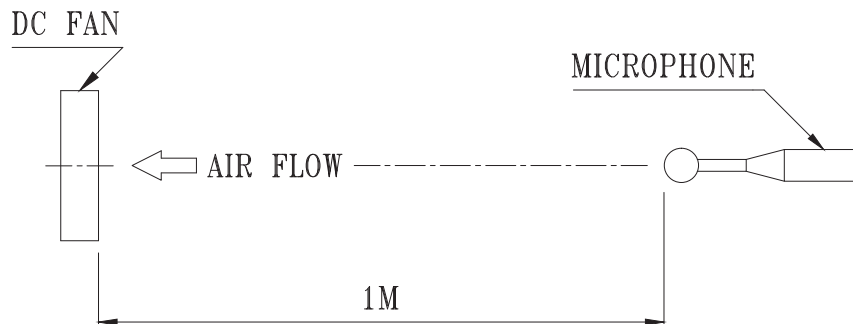

NOISE IS MEASURED AT RATED VOLTAGE IN FREE AIR IN ANECHOIC CHAMBER WITH B & K SOUND LEVEL METER WITH MICROPHONE AT A DISTANCE OF ONE METER FROM THE FAN INTAKE.

PART NO:

DELTA MODEL: QFR0812UHEYDW

3. MECHANICAL:

- 3-1. DIMENSIONS ----- SEE DIMENSIONS DRAWING
- 3-2. FRAME ----- PLASTIC UL: 94V-0
- 3-3. IMPELLER ----- PLASTIC UL: 94V-0
- 3-4. BEARING SYSTEM ----- TWO BALL BEARINGS
- 3-5. WEIGHT ----- 160 GRAMS(REF.)

4. ENVIRONMENTAL:

- 4-1. OPERATING TEMPERATURE ----- -10 TO +70 DEGREE C
- 4-2. STORAGE TEMPERATURE ----- -40 TO +75 DEGREE C
- 4-3. OPERATING HUMIDITY ----- 5 TO 90 % RH
- 4-4. STORAGE HUMIDITY ----- 5 TO 95 % RH

5. PROTECTION:

5-1. LOCKED ROTOR PROTECTION

IMPEDANCE OF MOTOR WINDING PROTECTS MOTOR FROM FIRE IN 96 HOURS OF LOCKED ROTOR CONDITION AT THE RATED VOLTAGE.

5-2. POLARITY PROTECTION

BE CAPABLE OF WITHSTANDING IF REVERSE CONNECTION FOR POSITIVE AND NEGATIVE LEADS.

6. RE OZONE DEPLETING SUBSTANCES:

- 6-1. NO CONTAINING PBBs, PBBOs, CFCs, PBBEs, PBDPEs AND HCFCs.

7. PRODUCTION LOCATION

- 7-1. PRODUCTS WILL BE PRODUCED IN CHINA OR THAILAND .

PART NO:

DELTA MODEL: QFR0812UHEYDW

8. P & Q CURVE:

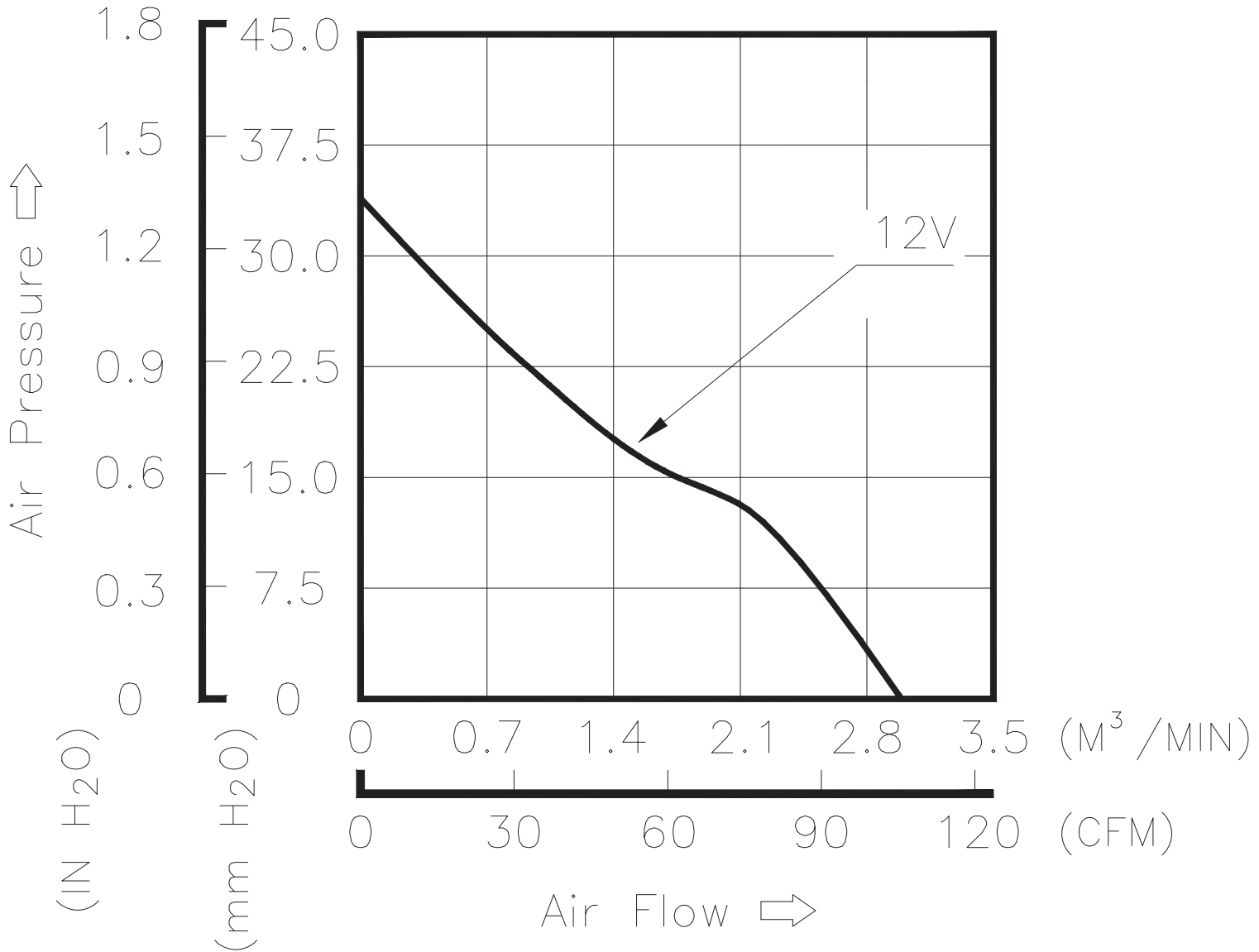

* TEST CONDITION: INPUT VOLTAGE ----- OPERATION VOLTAGE
 TEMPERATURE ----- ROOM TEMPERATURE
 HUMIDITY ----- 65%RH

PART NO:

DELTA MODEL: QFR0812UHEYDW

9. DIMENSIONS DRAWING

LABEL:

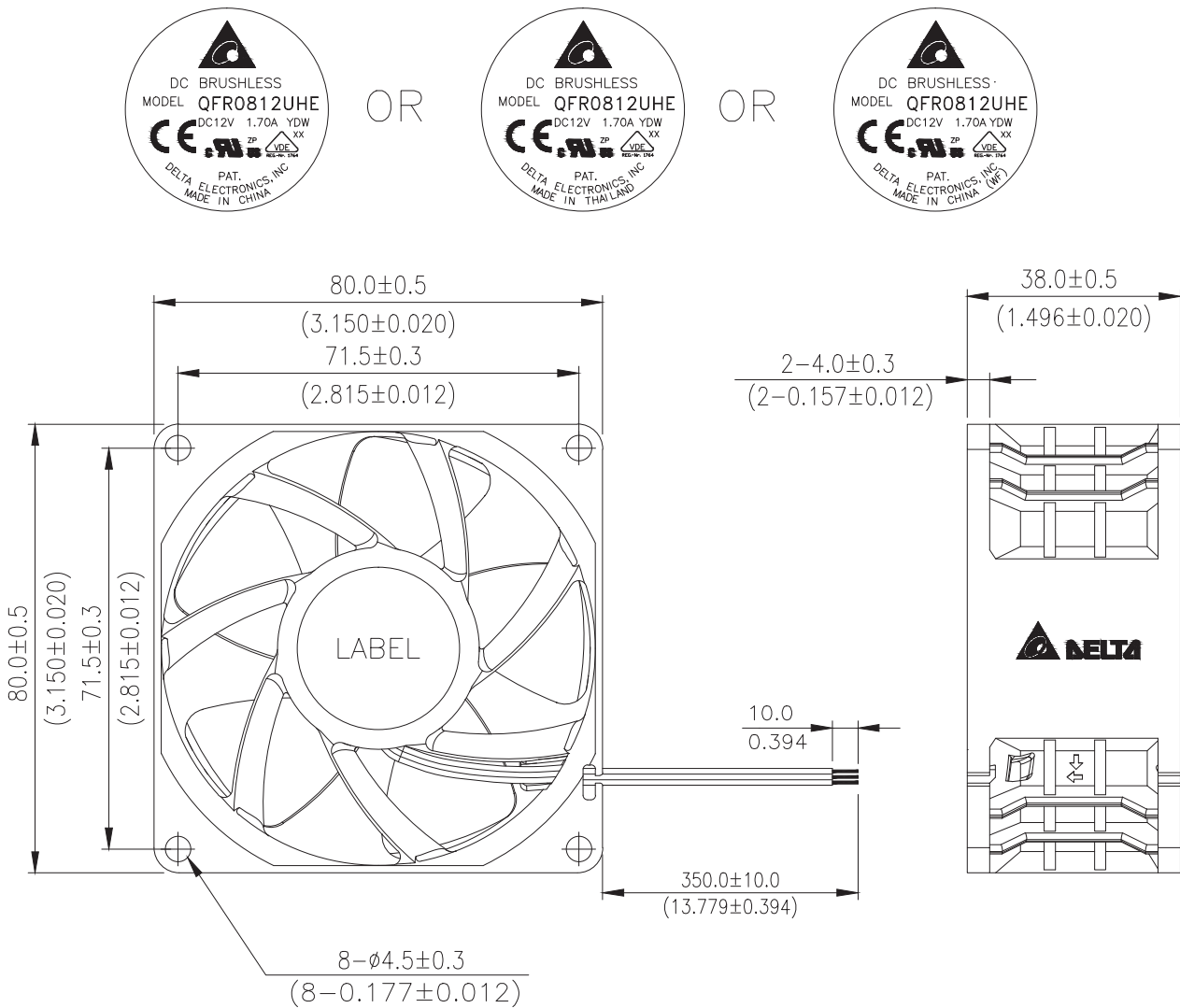

NOTES:

- LEAD WIRE: UL1061 AWG#24
RED WIRE ----- (+)
BLACK WIRE ----- (-)
BLUE WIRE ----- (PWM)
YELLOW WIRE ----- (FOO)
- THIS PRODUCT IS RoHS COMPLIANT.

A00

PART NO:

DELTA MODEL: QFR0812UHEYDW

10. FREQUENCY GENERATOR (FG) SIGNAL:

1. OUTPUT CIRCUIT – OPEN COLLECTOR MODE:

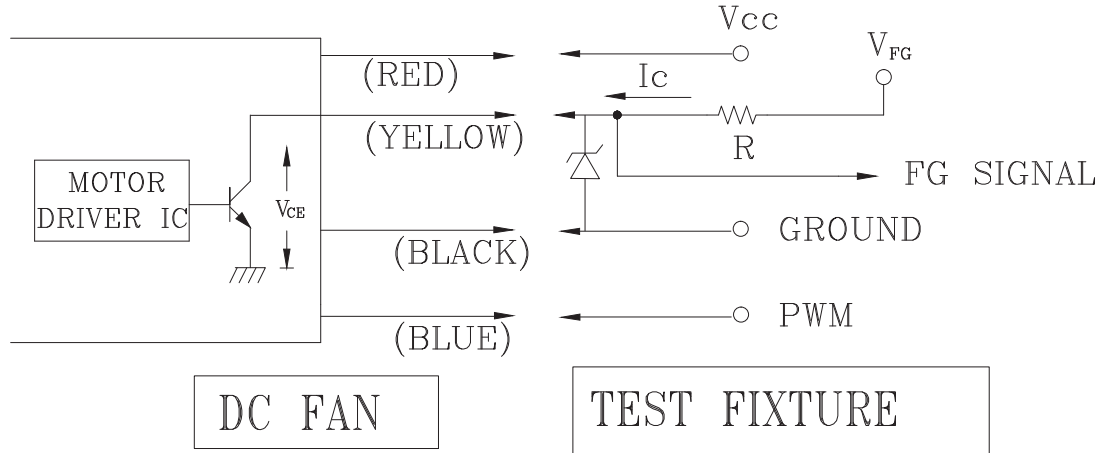

REMARK: TVS VOLTAGE DEFINE BY FACTORY.

CAUTION: THE FG SIGNAL LEAD WIRE MUST BE KEPT AWAY FROM
" + " LEAD WIRE & " - " LEAD WIRE.

2. SPECIFICATION:

$$V_{FG} = 5V \text{ TYP. (VCC MAX)} \quad I_c = 2mA \text{ MAX.}$$

$$V_{CE} = 0.5V \text{ MAX.} \quad R \geq V_{FG}/I_c$$

3. FREQUENCY GENERATOR WAVEFORM:

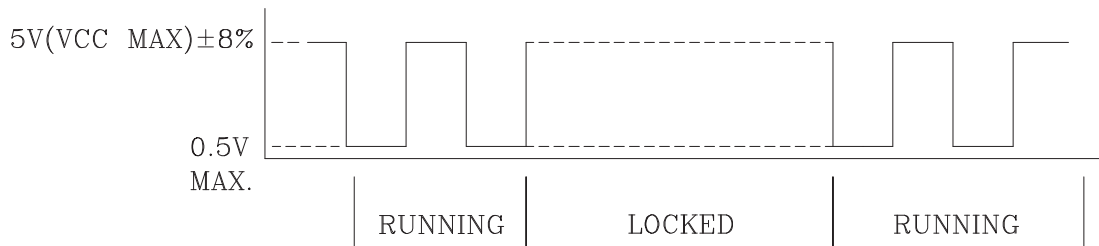

FAN RUNNING FOR 4 POLES

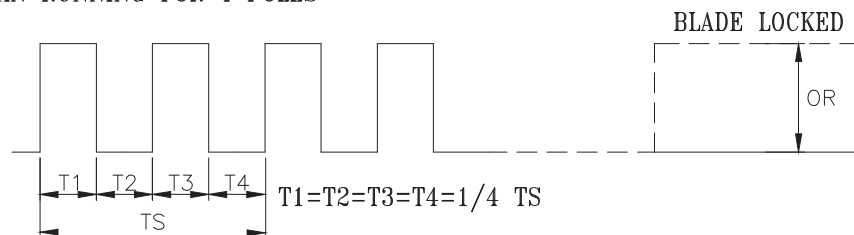

N=R.P.M

TS=60/N(SEC)

*VOLTAGE LEVEL AFTER BLADE LOCKED

*4 POLES

PART NO:

DELTA MODEL: QFR0812UHEYDW

11. PWM CONTROL SIGNAL:

SIGNAL VOLTAGE RANGE: 0 ~ 10VDC

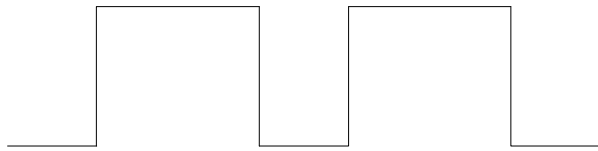

----- HIGH SIGNAL: 10 VDC MAX.
2.8 VDC MIN.

----- LOW SIGNAL: 0.8 VDC MAX.
0 VDC MIN.

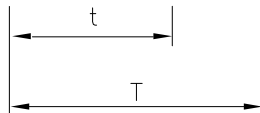

$$\text{DUTY CYCLE} = \frac{t}{T} * 100(\%)$$

- THE PREFERRED OPERATING POINT FOR THE FAN IS 25K HZ.
- AT 100% DUTY CYCLE,THE ROTOR WILL SPIN AT MAXIMUM SPEED.
- AT 0% DUTY CYCLE,THE ROTOR WILL BE STOPPED.
- WITH CONTROL SIGNAL LEAD DISCONNECTED,THE FAN WILL SPIN AT MAXIMUM SPEED.
- AT RATED VOLTAGE ,25K HZ ,20% DUTY CYCLE ,THE FAN WILL BE ABLE TO START FROM A DEAD STOP .

12. SPEED VS PWM CONTROL SIGNAL: (AT RATED VOLTAGE & PWM FREQUENCY=25KHZ & TEMPERATURE=25C)

DUTY CYCLE (%)	SPEED R.P.M. (REF.)	CURRENT (A) TYP.
100	9000±10%	1.15
0	0	0.02



Application Notice

- 1. Delta will not guarantee the performance of the products if the application condition falls outside the parameters set forth in the specification.**
- 2. A written request should be submitted to Delta prior to approval if deviation from this specification is required.**
- 3. Please exercise caution when handling fans. Damage may be caused when pressure is applied to the impeller, if the fans are handled by the lead wires, or if the fan was hard-dropped to the production floor.**
- 4. Except as pertains to some special designs, there is no guarantee that the products will be free from any such safety problems or failures as caused by the introduction of powder, droplets of water or encroachment of insect into the hub.**
- 5. The above-mentioned conditions are representative of some unique examples and viewed as the first point of reference prior to all other information.**
- 6. It is very important to establish the correct polarity before connecting the fan to the power source. Positive (+) and Negative (-). Damage may be caused to the fans if connection is with reverse polarity, if there is no foolproof method to protect against such error specifically mentioned in this spec.**
- 7. Delta fans without special protection are not suitable where any corrosive fluids are introduced to their environment.**
- 8. Please ensure all fans are stored according to the storage temperature limits specified. Do not store fans in a high humidity environment. We highly recommend performance testing is conducted before shipping, if the fans have been stored over 6 months.**
- 9. Not all fans are provided with the Lock Rotor Protection feature. If you impair the rotation of the impeller for the fans that do not have this function, the performance of those fans will lead to failure.**
- 10. Please be cautious when mounting the fan. Incorrect mounting of fans may cause excess resonance, vibration and subsequent noise.**
- 11. It is important to consider safety when testing the fans. A suitable fan guard should be fitted to the fan to guard against any potential for personal injury.**
- 12. Except where specifically stated, all tests are carried out at room (ambient) temperature and relative humidity conditions of 25°C, 65% RH. The test value is only for fan performance itself.**
- 13. Be certain to connect an “ 4.7 μ F or greater” capacitor to the fan externally when the application calls for using multiple fans in parallel, to avoid any unstable power.**